

**RED** MACHINE s.r.o.

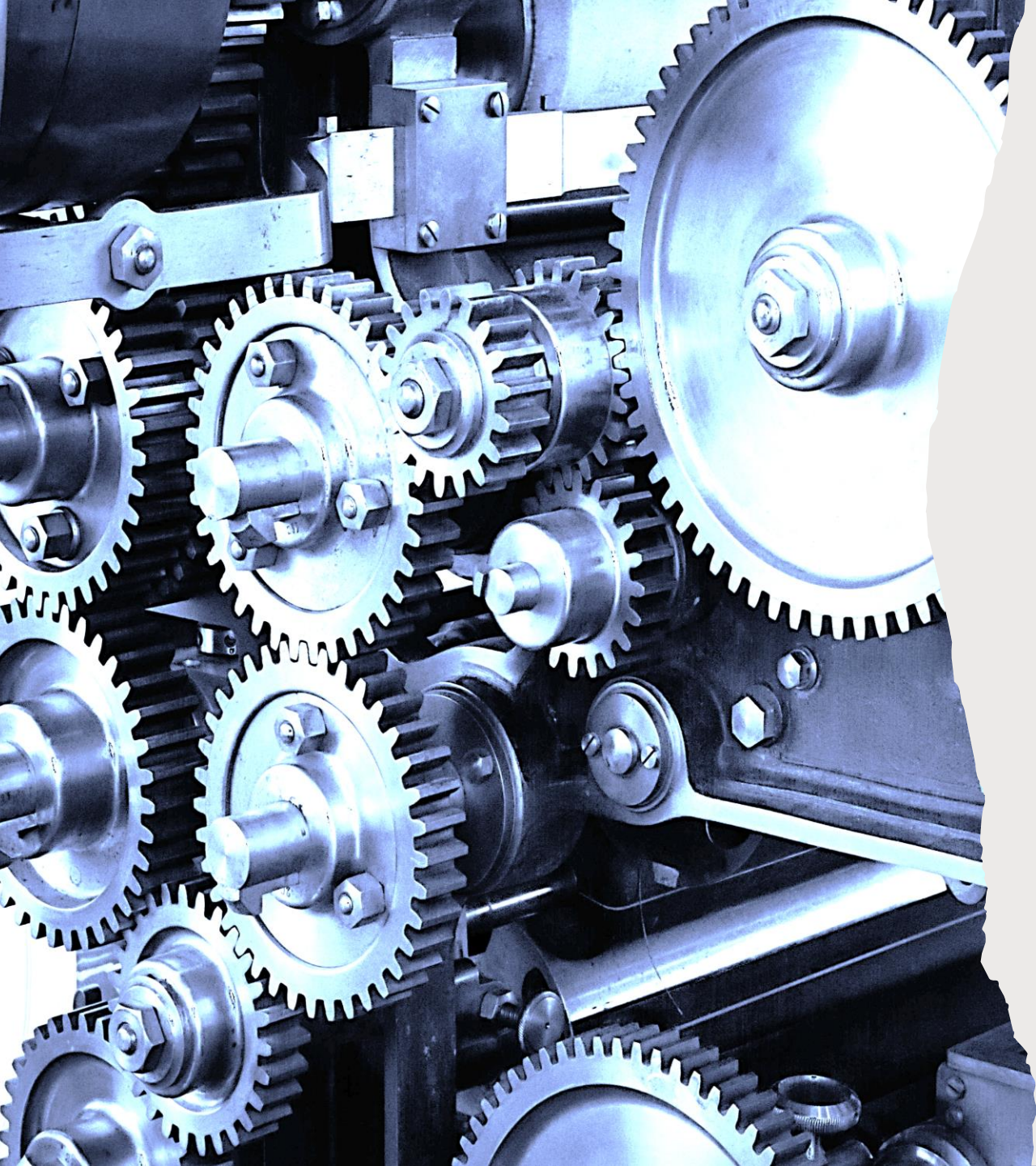



**RED** MACHINE s.r.o.

# **SMALL MACHINES**



# SMALL MACHINES

## AUTOMOTIVE

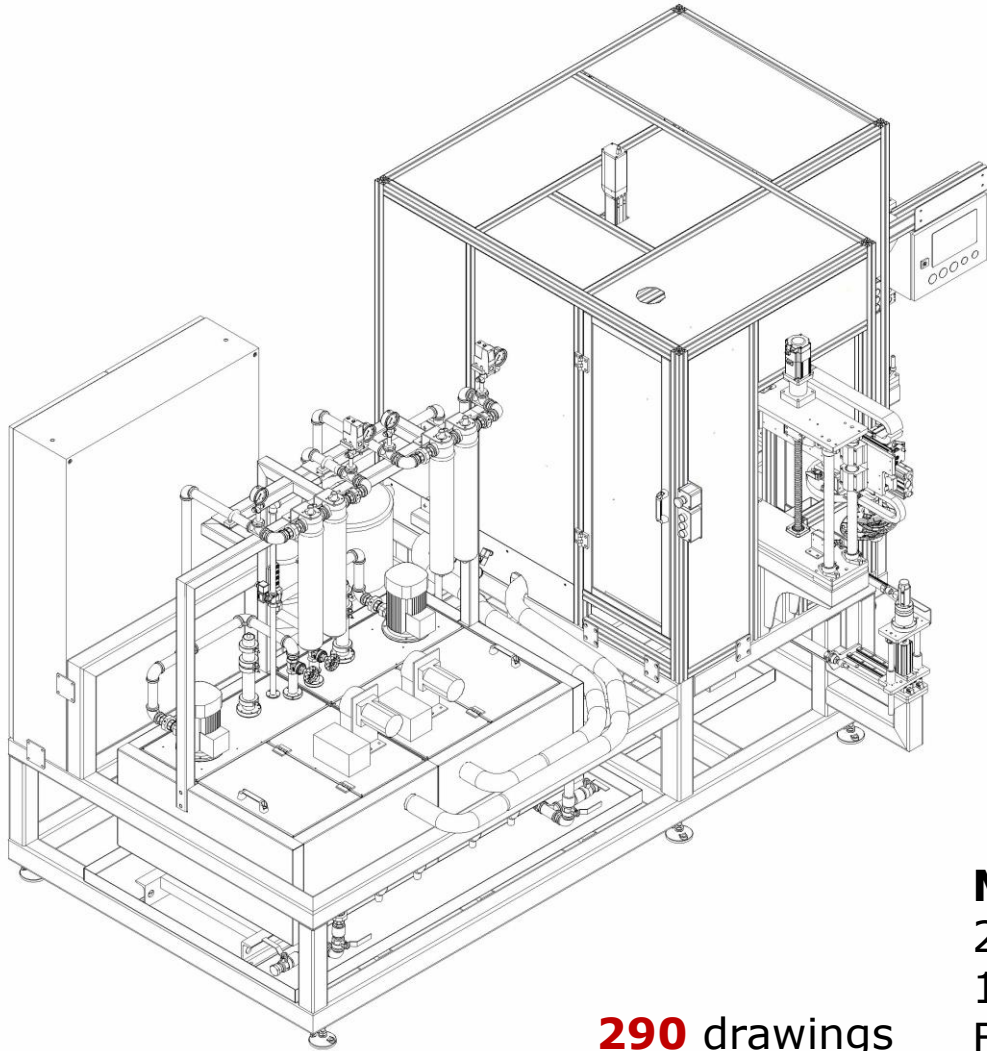

**290** drawings  
**1280** pieces

### MAIN PARTS:

2x 3-axis manipulators  
1x carousel with 6 positions  
Fluid management  
Presence control of parts

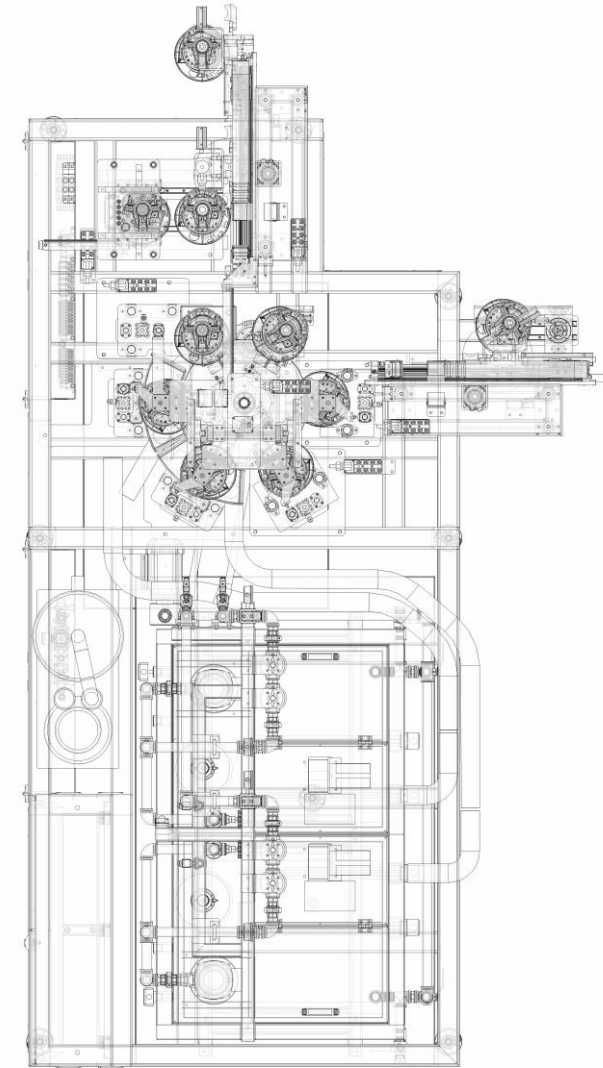

# SMALL MACHINES

AUTOMOTIVE

**RED** MACHINE s.r.o.

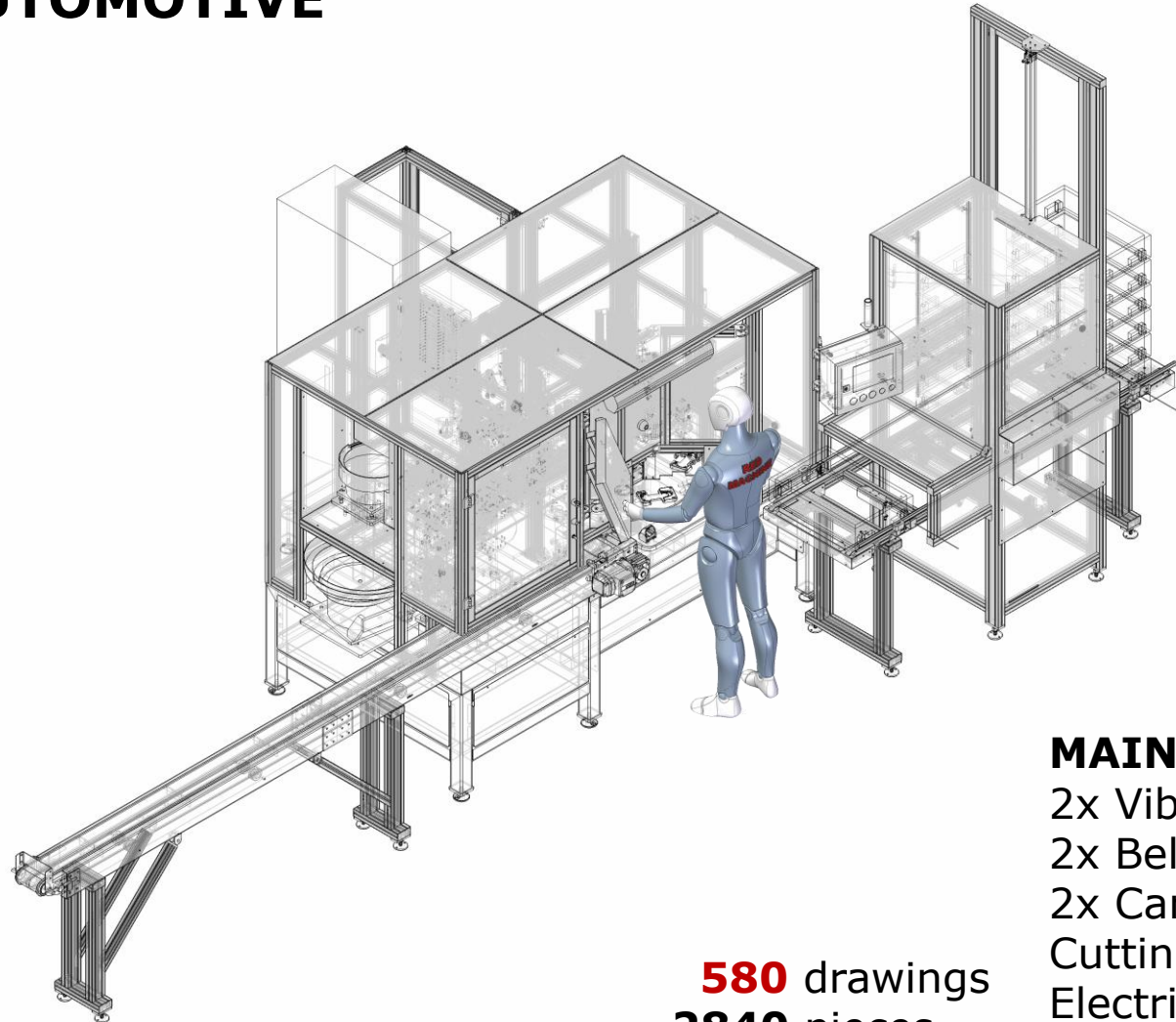

**580** drawings  
**2840** pieces

## MAIN PARTS:

2x Vibratory feeders  
2x Belt conveyors  
2x Carousels with 4+8 positions  
Cutting  
Electric screwing  
Camera inspection

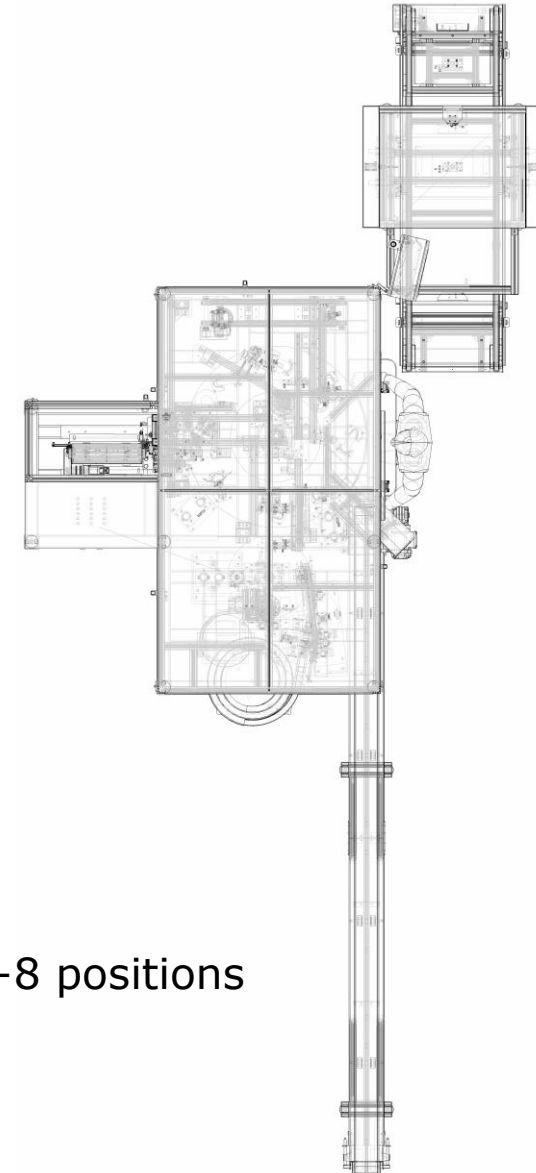

# SMALL MACHINES

ENERGETIC SAVINGS

**RED** MACHINE s.r.o.

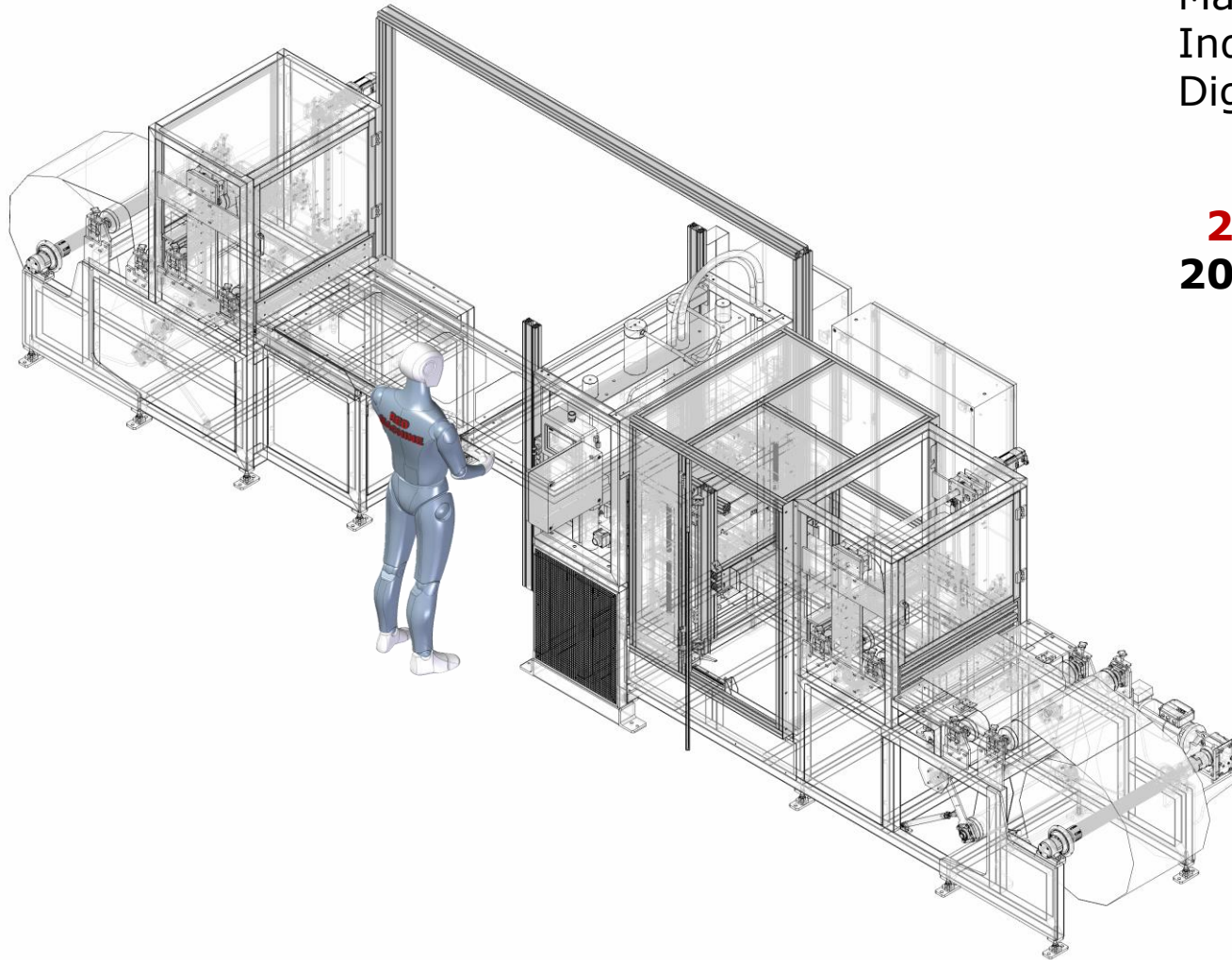

## MAIN PARTS:

Material unwinding

Induction heating

Digital hydraulic press

**220** drawings

**2070** pieces

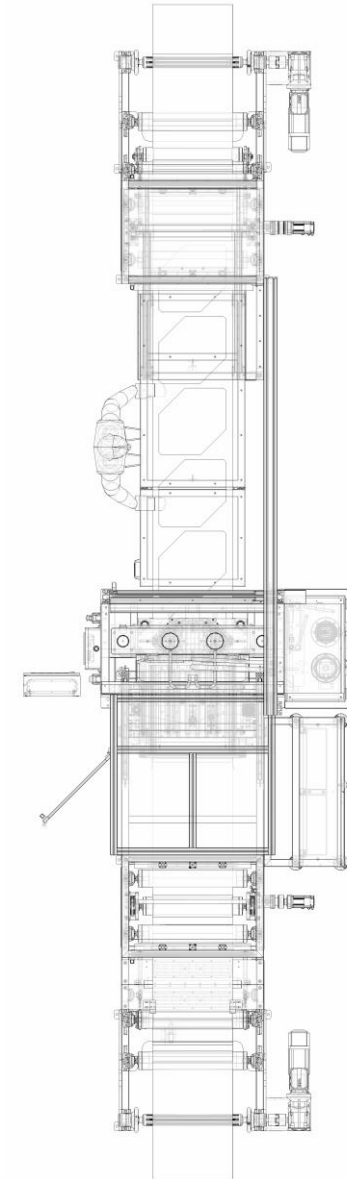



# SMALL MACHINES

## AUTOMOTIVE

**RED** MACHINE s.r.o.

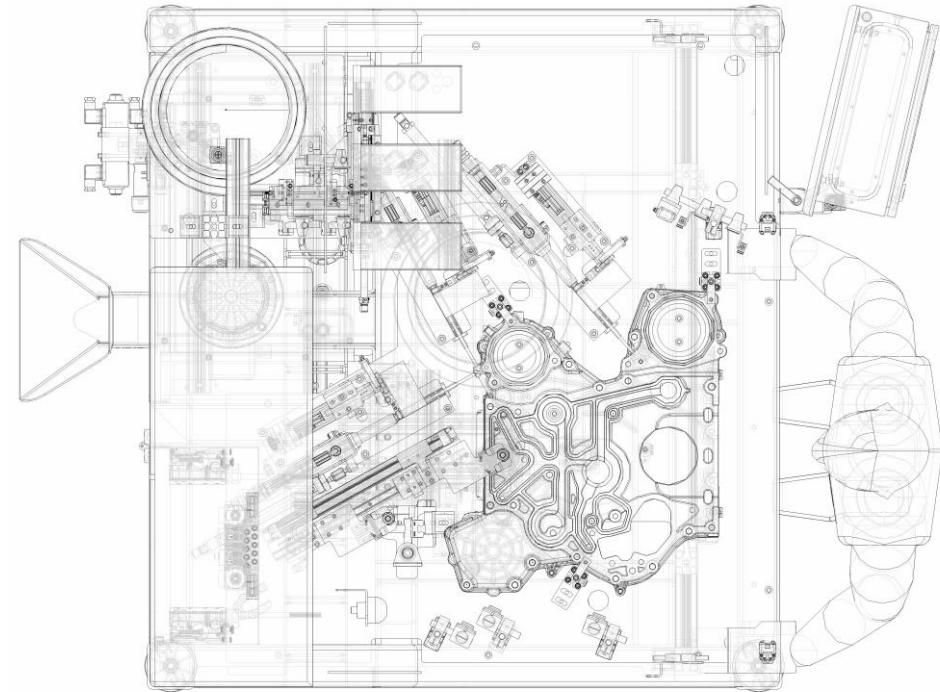
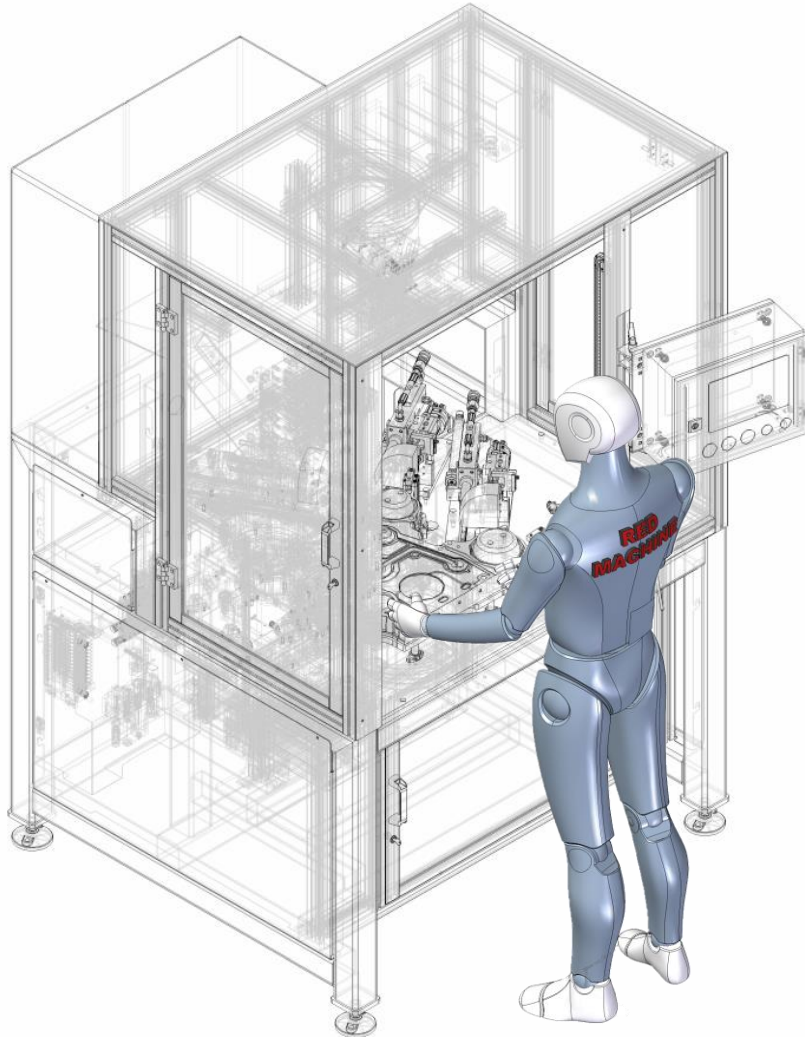

### MAIN PARTS:

2x vibration feeder  
3x press heads  
Hydraulic unit  
Electric screwdriving

**210** drawings  
**1380** pieces

# SMALL MACHINES

## BUILDING SAFETY

**RED** MACHINE s.r.o.

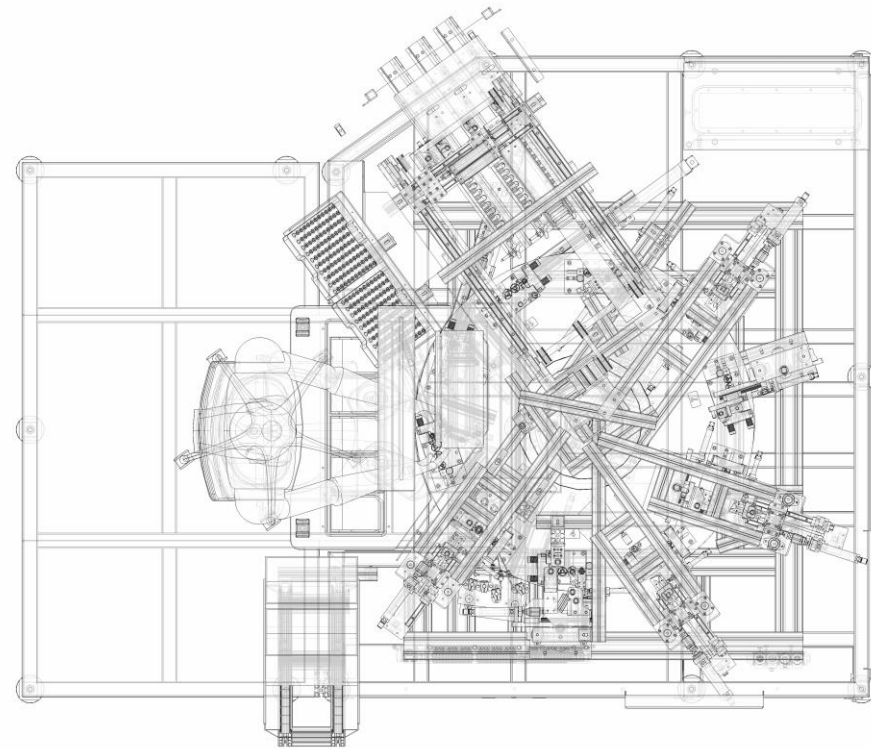
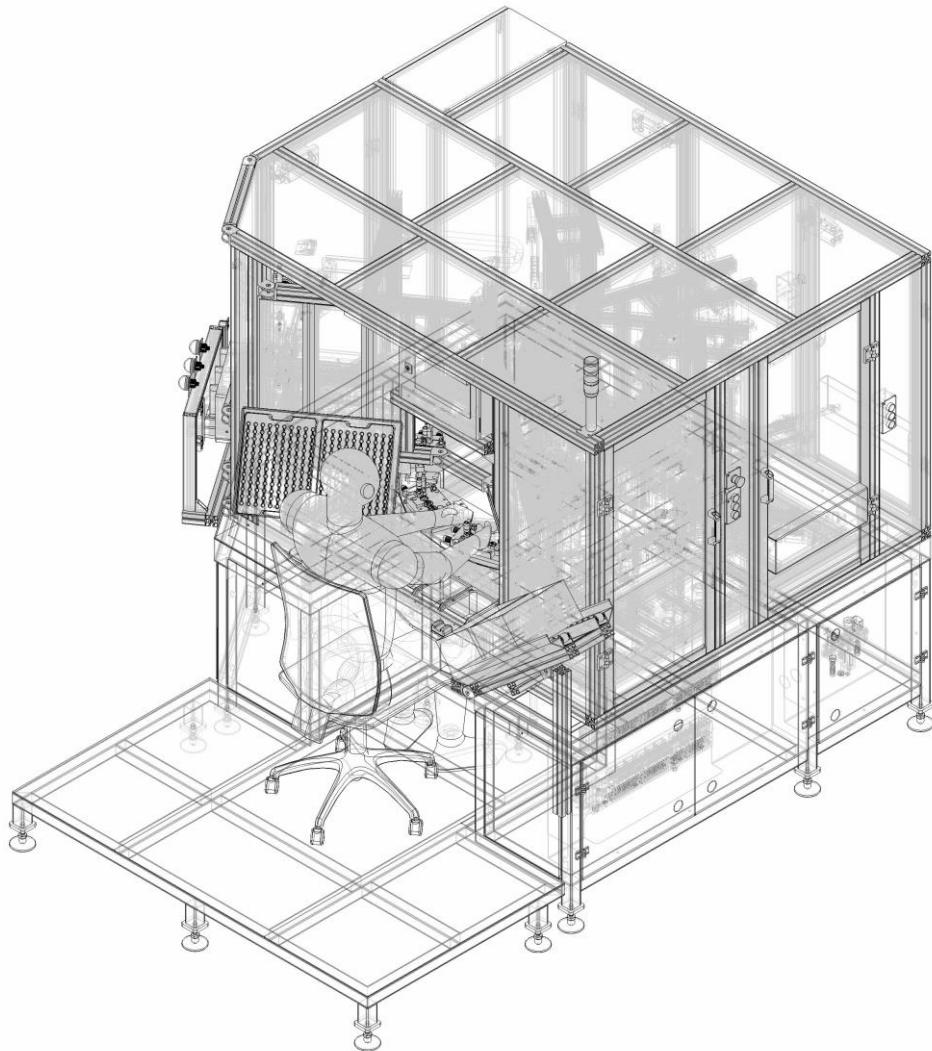

### MAIN PARTS:

1x 10-position carousel

part presence check

3-axis manipulator

**280** drawings  
**1810** pieces

# RED MACHINE s.r.o.



**DANIELA VASATKOVA**  
Sales Manager

[daniela.vasatkova@redmachine.cz](mailto:daniela.vasatkova@redmachine.cz)  
[www.redmachine.cz](http://www.redmachine.cz)